

# Data Sheet



Article number: 0125079

Description: Retaining ring SP65  
Spring steel

## Measures

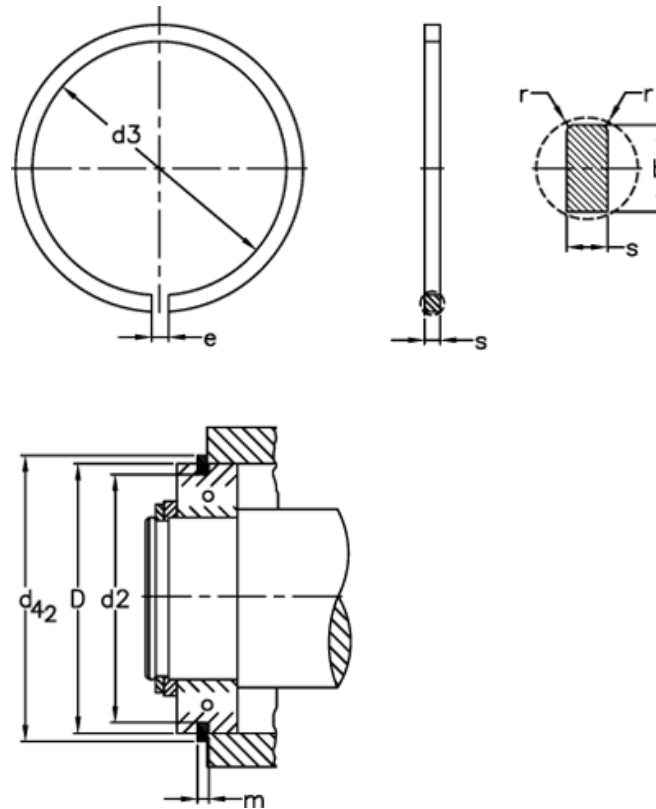

b	= 4.04	FRg kN	= 5.89	tol	= -0.15
D	= 65	FR kN	= 34.9	tol	= -0.1
d2	= 62.60	g	= 2.5	tol	= -0.50
d3	= 61.2	K kN-mm	= 65.3	tol	= 0.3
d42	= 70.7	m	= 1.90	tol	= 0.8
Description	= SP 65	n abl x 1000	= 4.0	Weight kg/1000	= 11.0
e	= 4	r min	= 0.6		
FN kN	= 40.0	s	= 1.70		